

€30,70

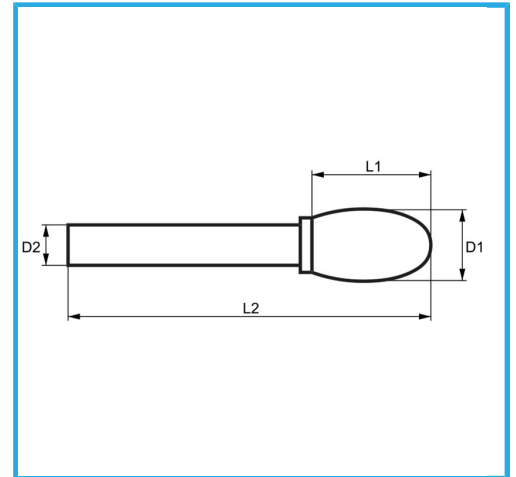

D1	12 mm
L1	20 mm
D2	6 mm
L2	65 mm
Dimensioni imballo	95 x 20 x 20 h mm
Peso lordo	0,04 kg
Codice EAN	8012667357344

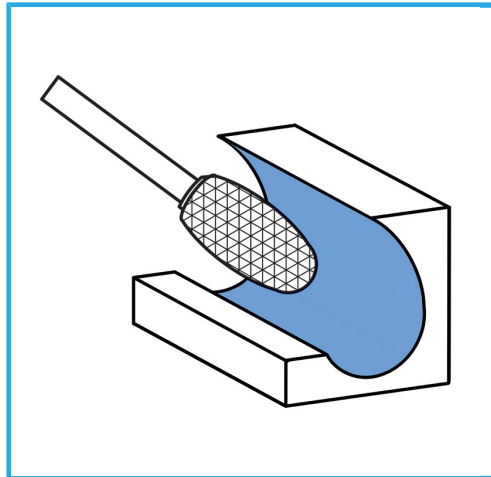

Scatola



-