

€30,10

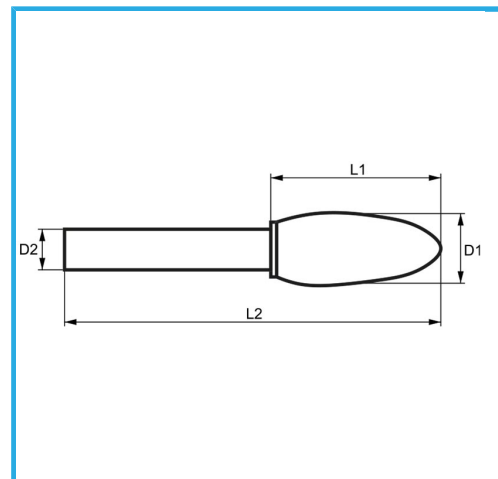

D1	ø12 mm
D2	6 mm
L1	32 mm
L2	77 mm
Dimensioni imballo	95 x 20 x 20 h mm
Peso lordo	0,05 kg
Codice EAN	8012667357689

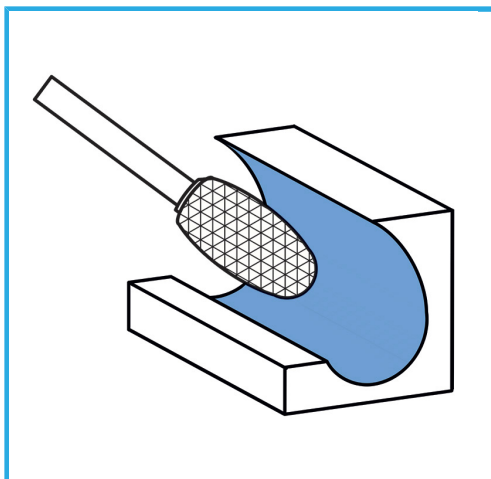

Scatola



HM