

SPECIFICO PER RIPARAZIONI O RINFORZI SEDI CANDELE.

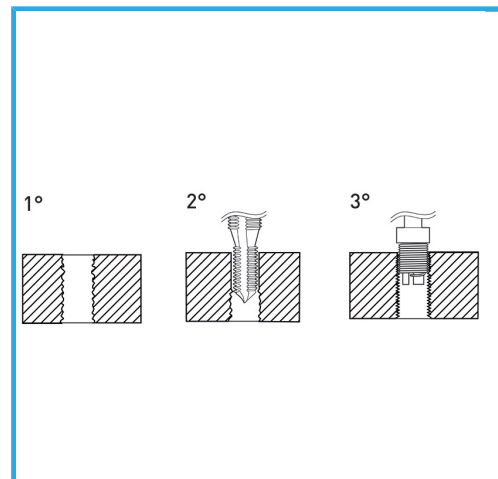

€43,70

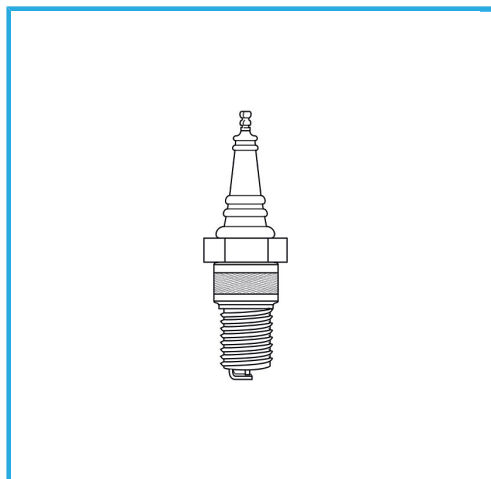

Misura	M 6 x 1.0
Utensile montaggio	E011/U09
Maschi STI	E011/M060X100M
Inseri filettati	10
Codice EAN	8012667366483
Peso lordo	-



Append.

HSS

INOX